

GDT550/16

Stud Thyristor

Phase controlled Thyristor

Features

- Hermetic metal case with glass insulator
- Threaded stud ISO M24x1,5
- High i^2t and I_{TSM} values for easy fusing
- International standard case

Typical Applications

- DC motor control (e. g. for machine tools)
- Controlled rectifiers (e. g. for battery charging)
- AC controllers (e. g. for temperature control)
- Recommended snubber network e. g. for $V_{VRMS} \leq 400$ V:
 $R = 33 \Omega/32$ W, $C = 0,47 \mu F$

V_{RSM} V	V_{RRM}, V_{DRM} V	$I_{TRMS} = 550$ A (maximum value for continuous operation) $I_{TAV} = 300$ A (sin. 180; $T_c = 93$ °C)	
1700	1600	GDT550/16	

Symbol	Conditions	Values	Units
I_{TAV}	sin. 180; $T_c = 100$ (85) °C;	257 (351)	A
I_{TSM}	$T_{vj} = 25$ °C; 10 ms $T_{vj} = 130$ °C; 10 ms	11000 10000	A A
i^2t	$T_{vj} = 25$ °C; 8,35 ... 10 ms $T_{vj} = 130$ °C; 8,35 ... 10 ms	600000 500000	A ² s A ² s
V_T	$T_{vj} = 25$ °C; $I_T = 800$ A	max. 1,45	V
$V_{T(TO)}$	$T_{vj} = 130$ °C	max. 0,9	V
r_T	$T_{vj} = 130$ °C	max. 0,5	mΩ
$I_{DD}; I_{RD}$	$T_{vj} = 130$ °C; $V_{RD} = V_{RRM}; V_{DD} = V_{DRM}$	max. 50	mA
t_{gd}	$T_{vj} = 25$ °C; $I_G = 1$ A; $di_G/dt = 1$ A/μs	1	μs
t_{gr}	$V_D = 0,67 * V_{DRM}$	2	μs
$(di/dt)_{cr}$	$T_{vj} = 130$ °C	max. 100	A/μs
$(dv/dt)_{cr}$	$T_{vj} = 130$ °C; SKT ...D / SKT ...E	max. 500 / 1000	V/μs
t_q	$T_{vj} = 130$ °C,	50 ... 150	μs
I_H	$T_{vj} = 25$ °C; typ. / max.	150 / 250	mA
I_L	$T_{vj} = 25$ °C; $R_G = 33 \Omega$; typ. / max.	300 / 600	mA
V_{GT}	$T_{vj} = 25$ °C; d.c.	min. 3	V
I_{GT}	$T_{vj} = 25$ °C; d.c.	min. 200	mA
V_{GD}	$T_{vj} = 130$ °C; d.c.	max. 0,25	V
I_{GD}	$T_{vj} = 130$ °C; d.c.	max. 10	mA
$R_{th(j-c)}$	cont.	0,09	K/W
$R_{th(j-c)}$	sin. 180	0,096	K/W
$R_{th(j-c)}$	rec. 120	0,101	K/W
$R_{th(c-s)}$		0,015	K/W
T_{vj}		- 40 ... + 130	°C
T_{stg}		- 55 ... + 150	°C
V_{isol}		-	V~
M_s	to heatsink	60 (UNF: 30)	Nm
a		5 * 9,81	m/s ²
m	approx.	490	g
Case		B 7	



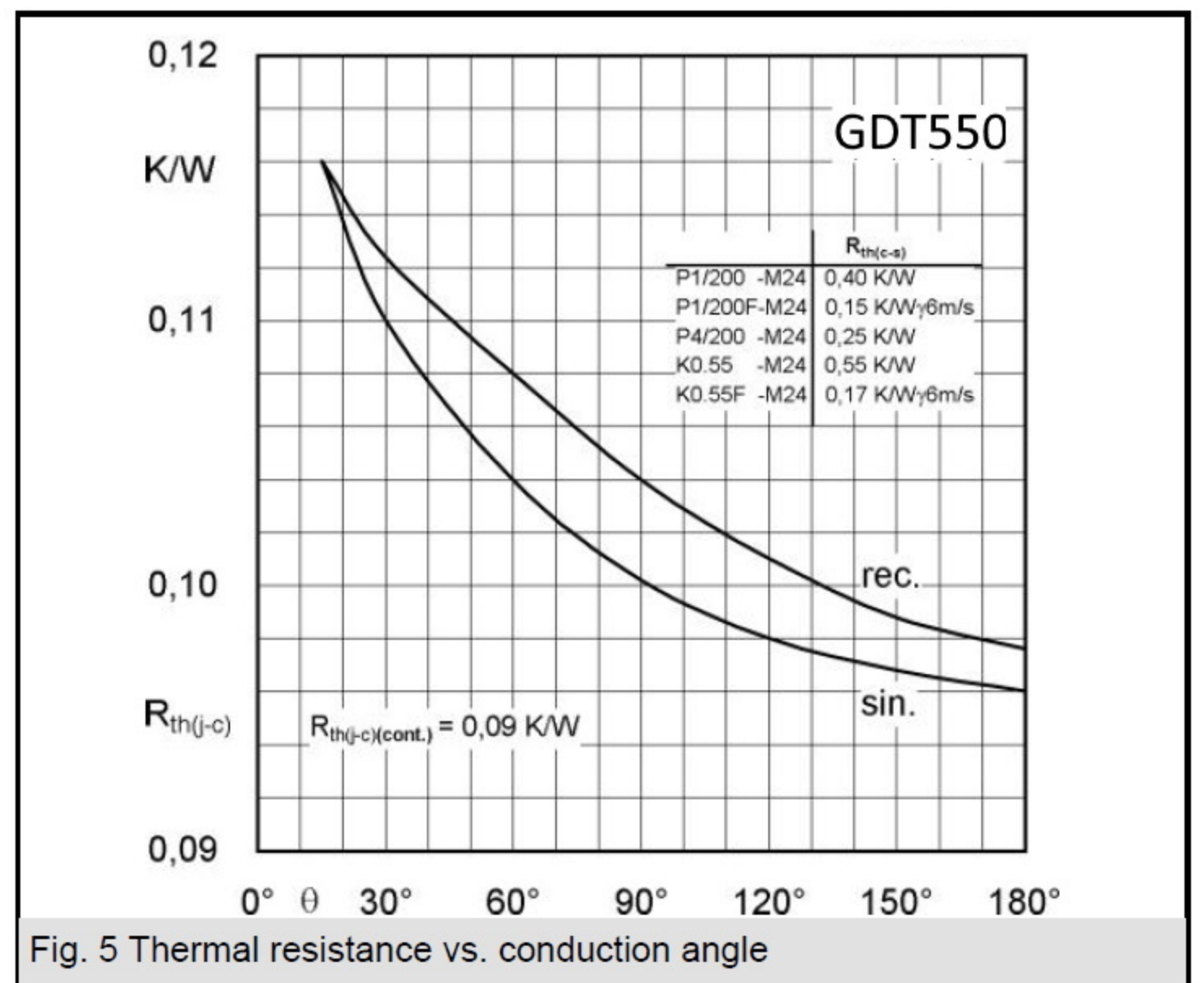
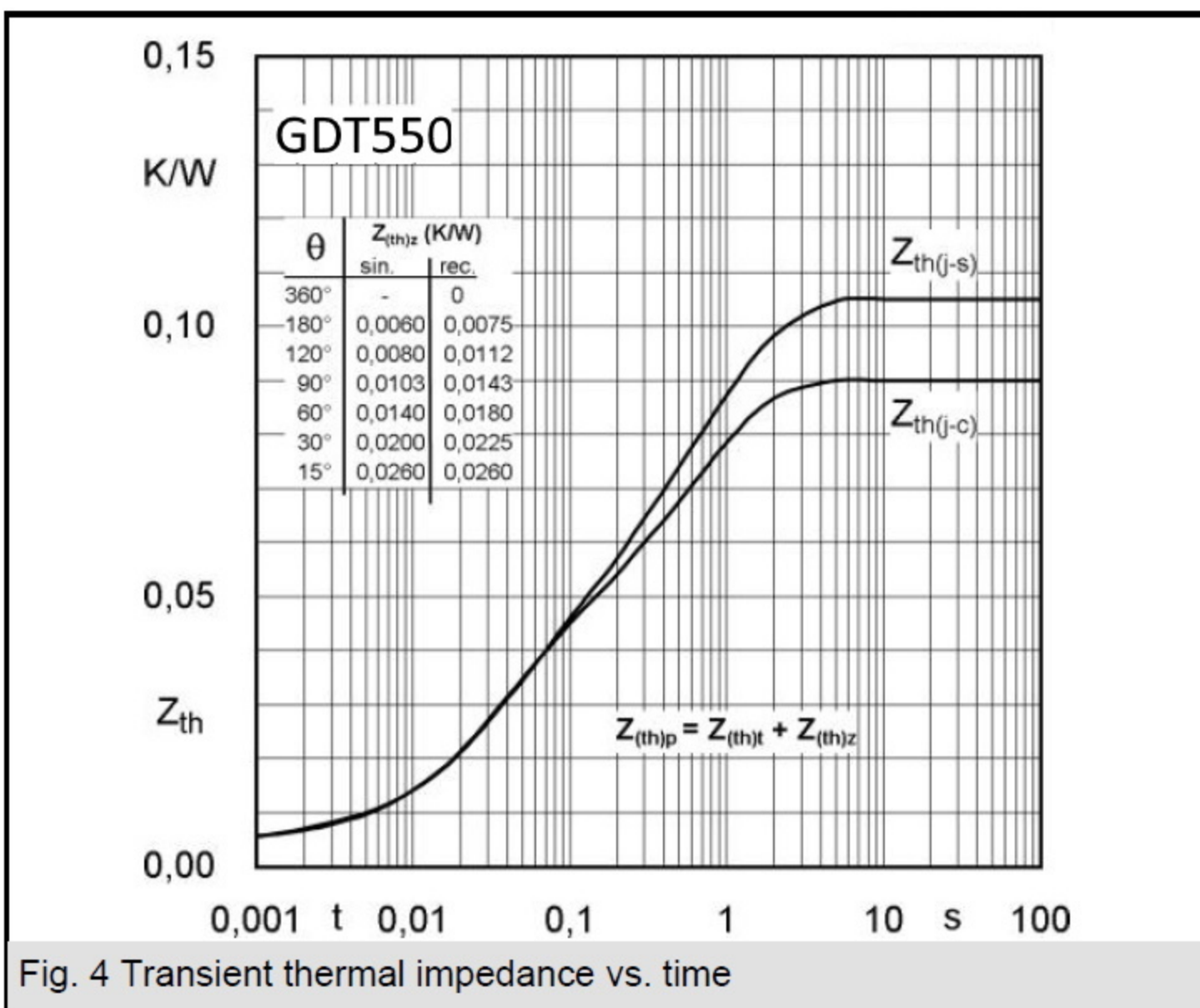
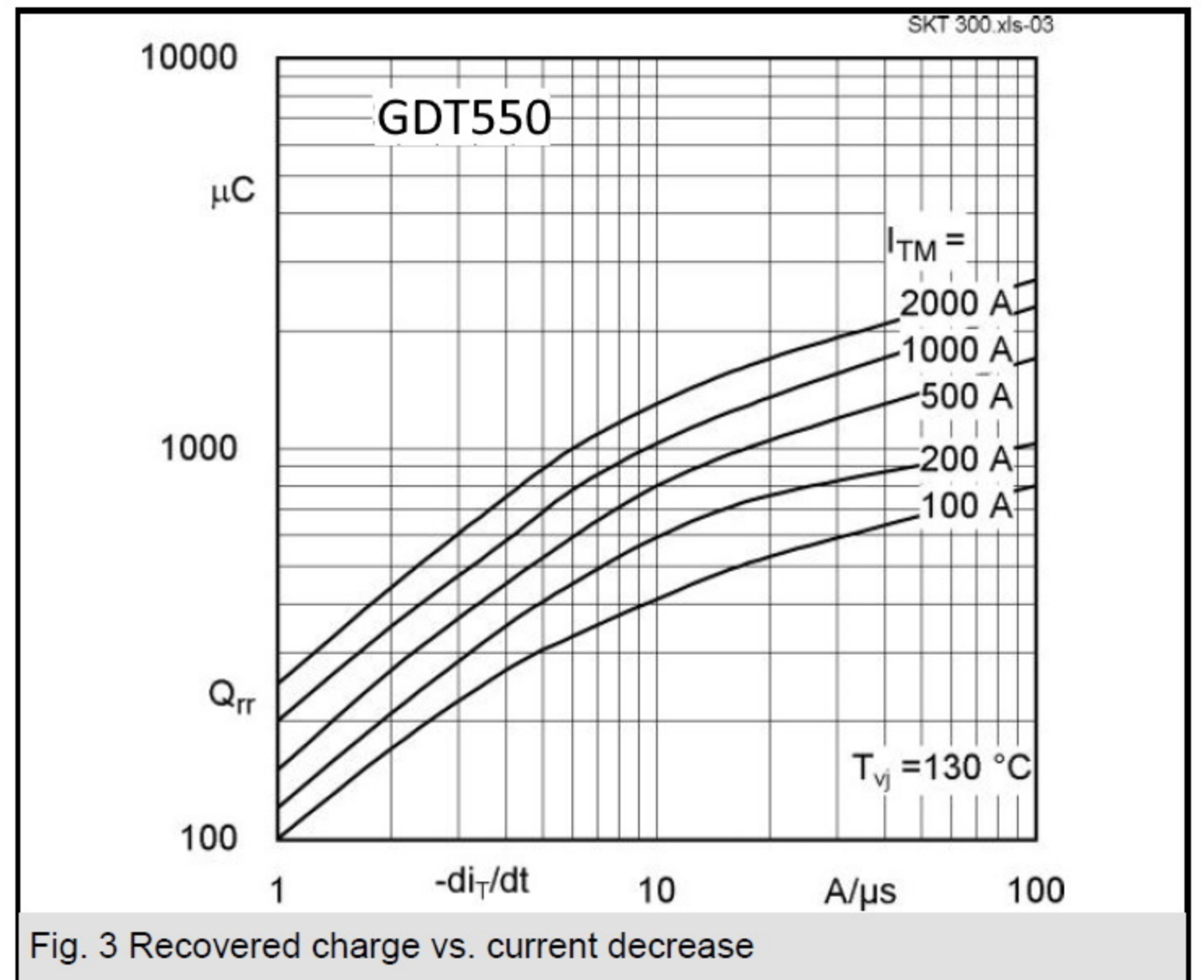
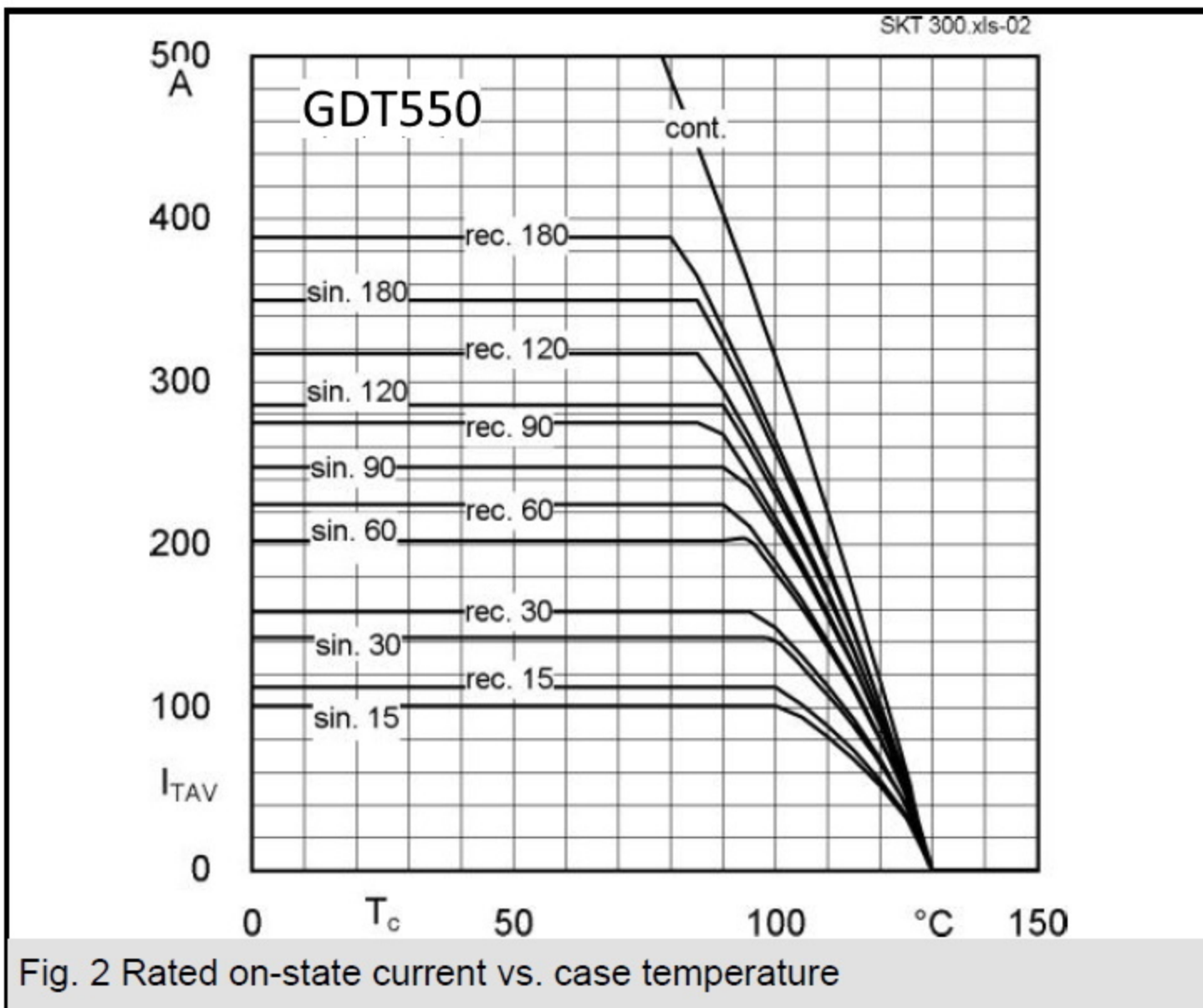
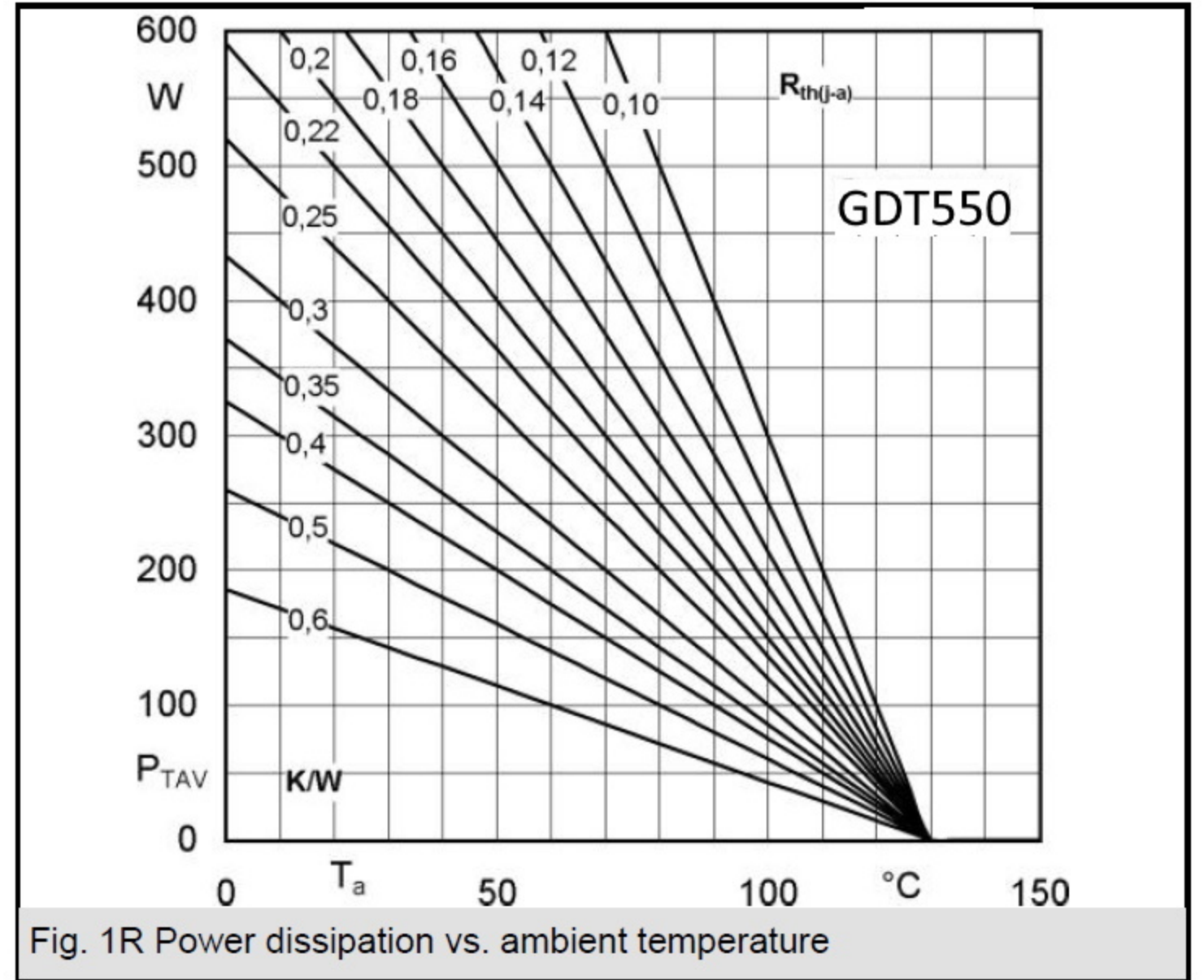
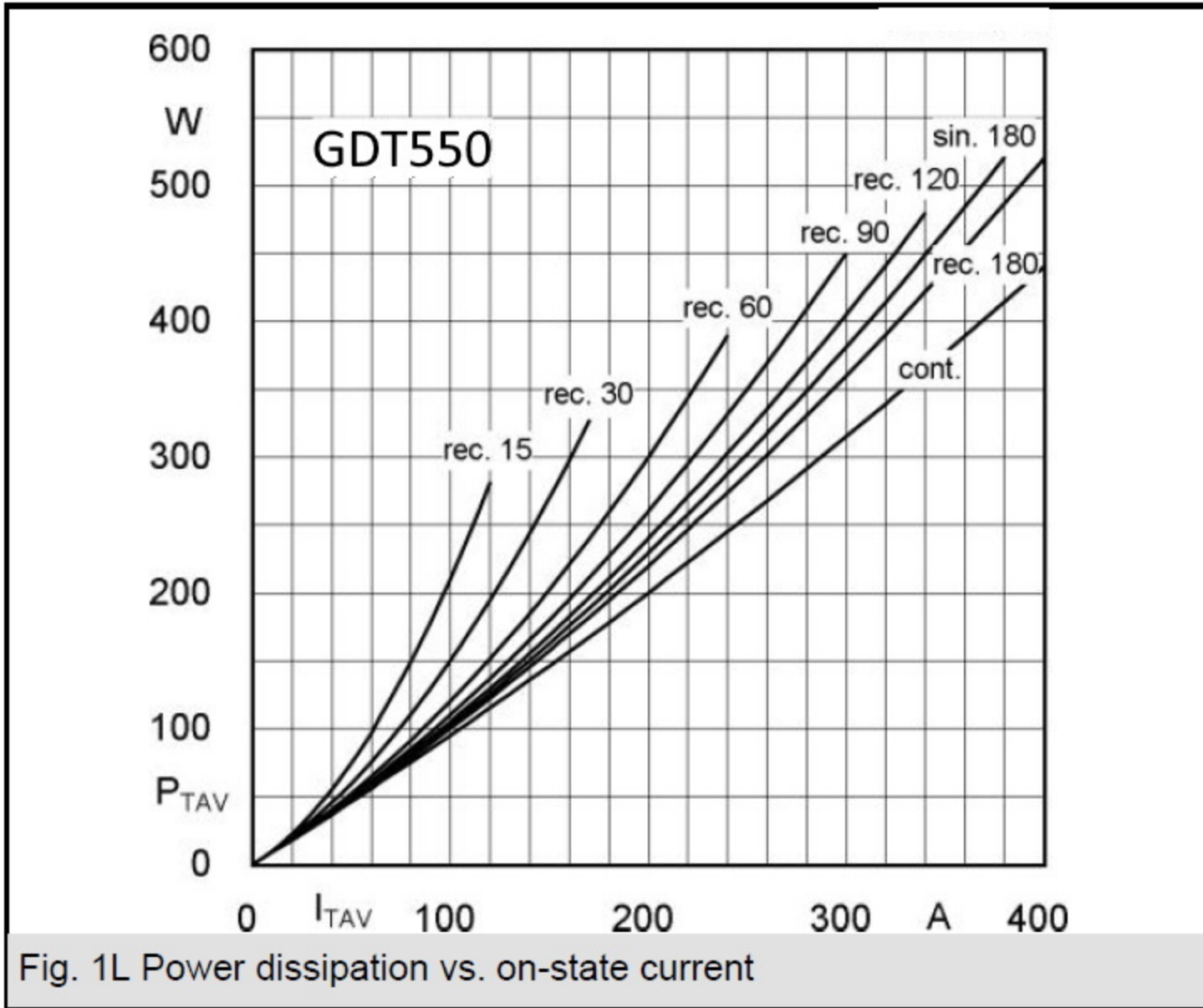

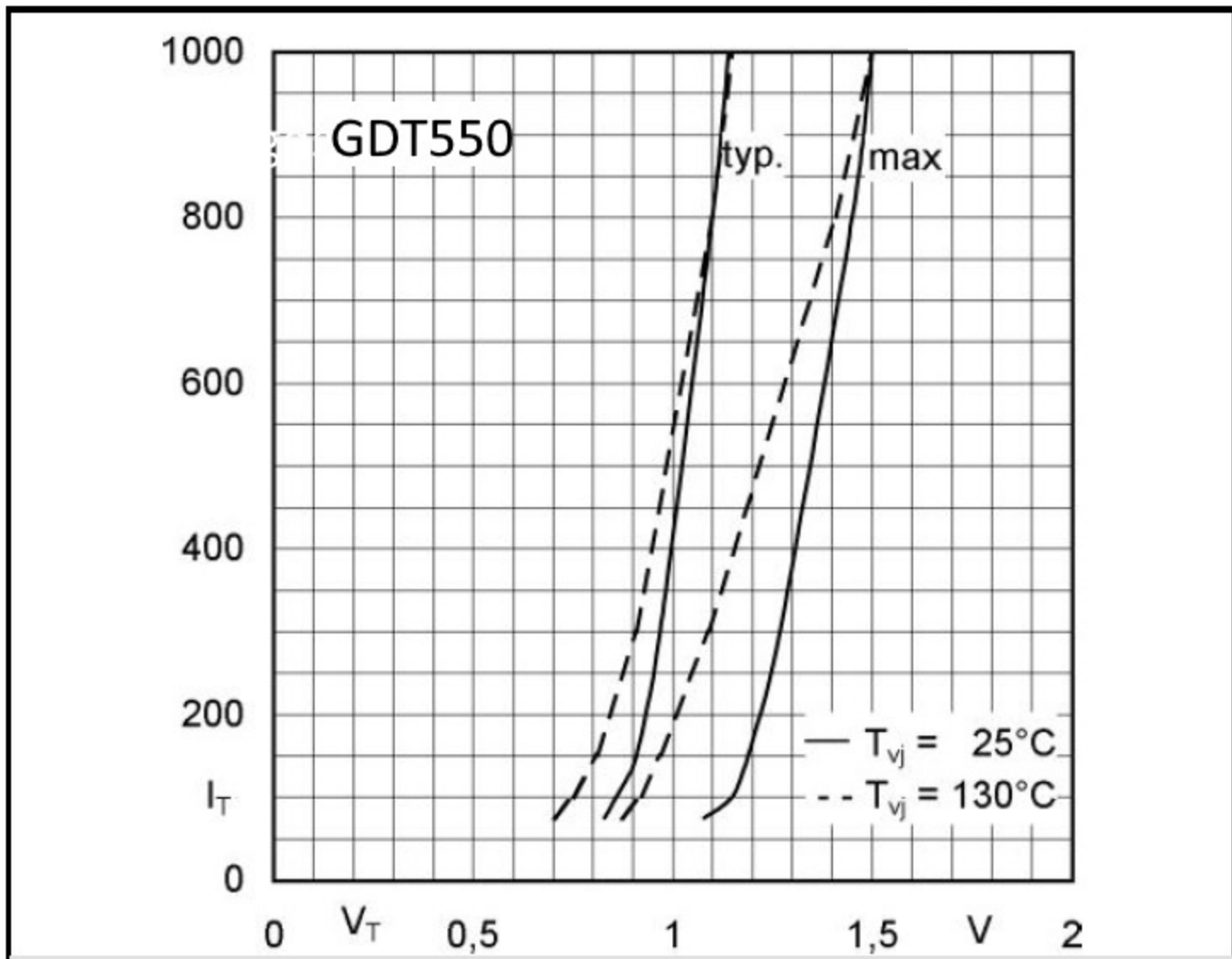

Fig. 6 On-state characteristics

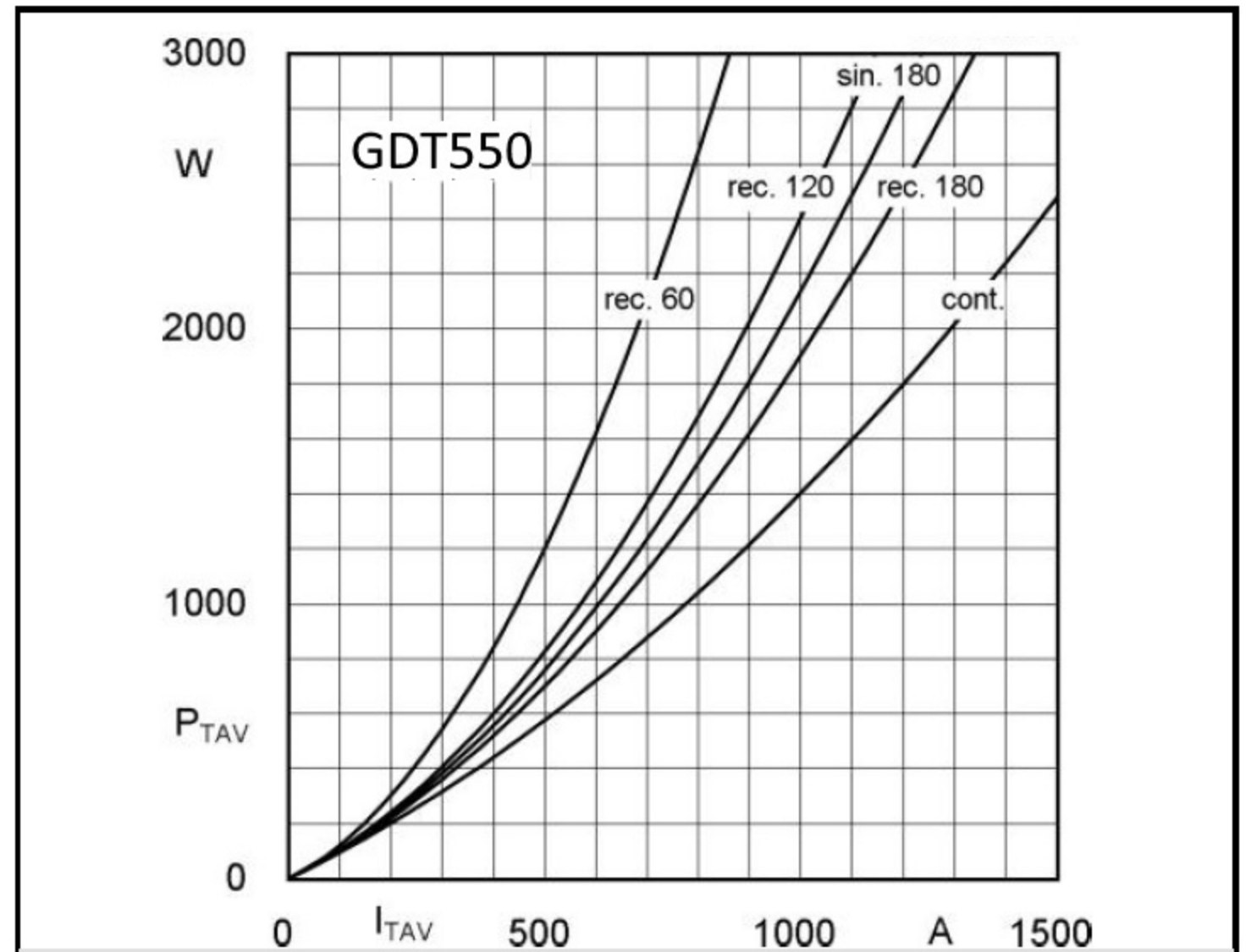

Fig. 7 Power dissipation vs. on-state current

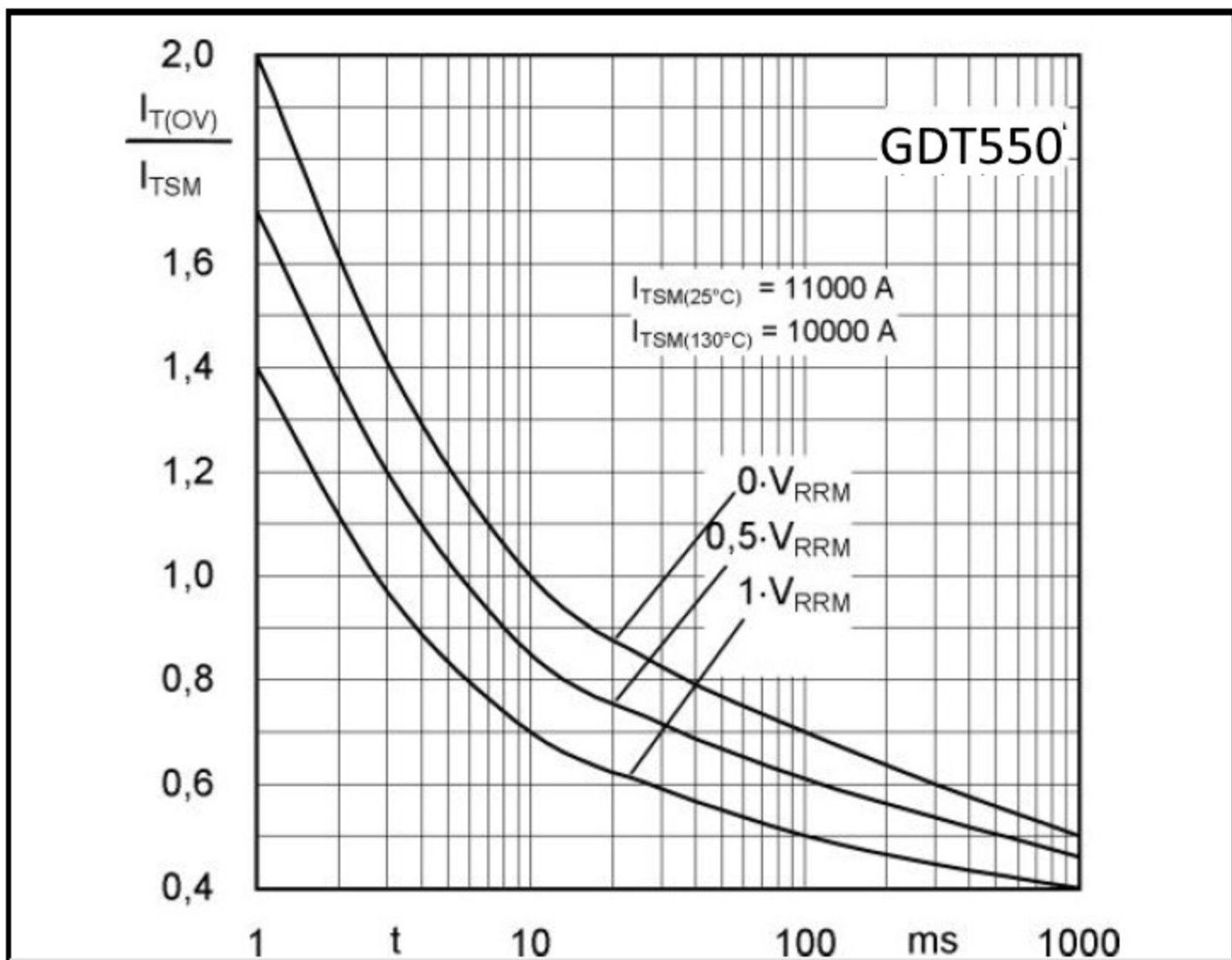

Fig. 8 Surge overload current vs. time

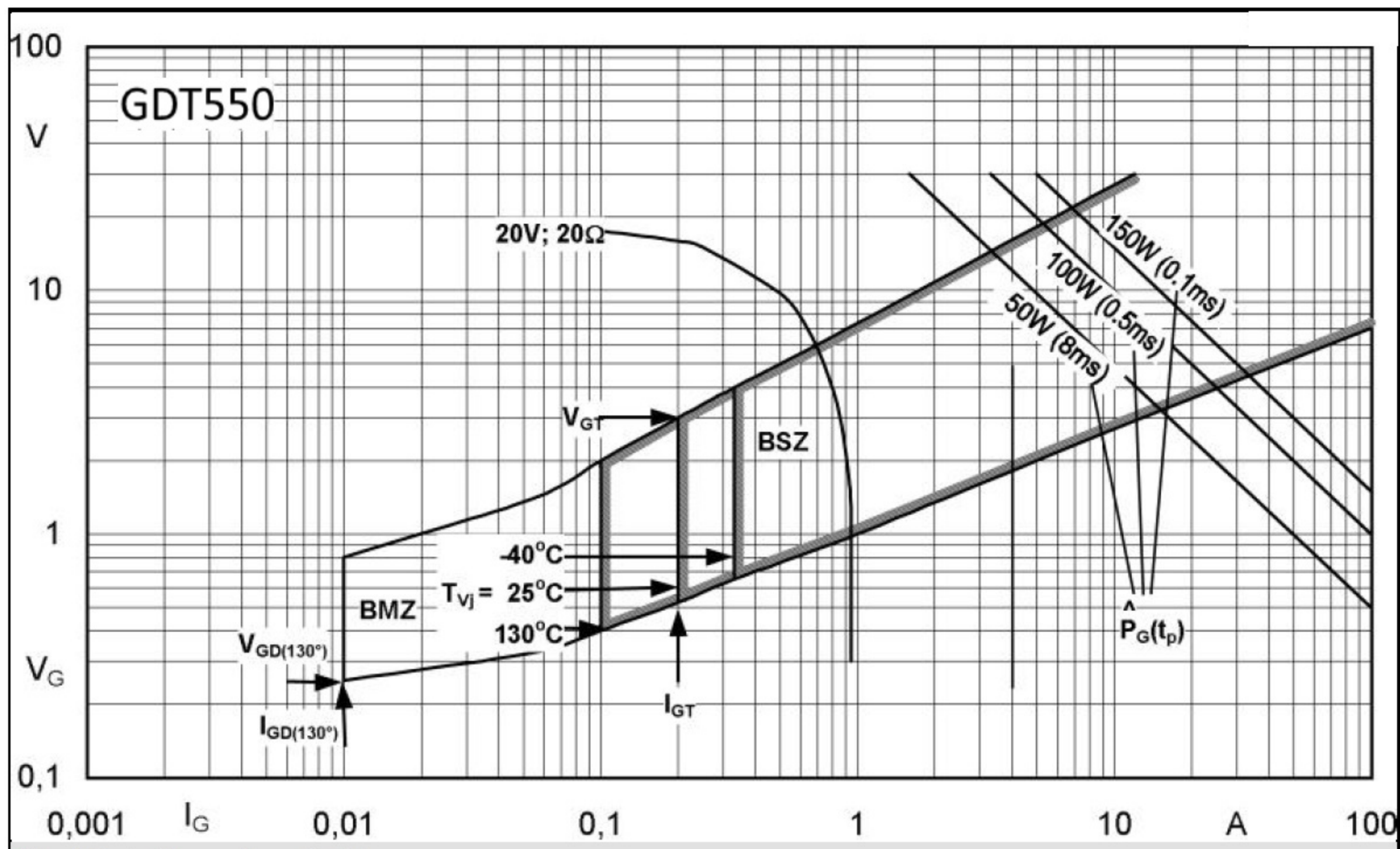
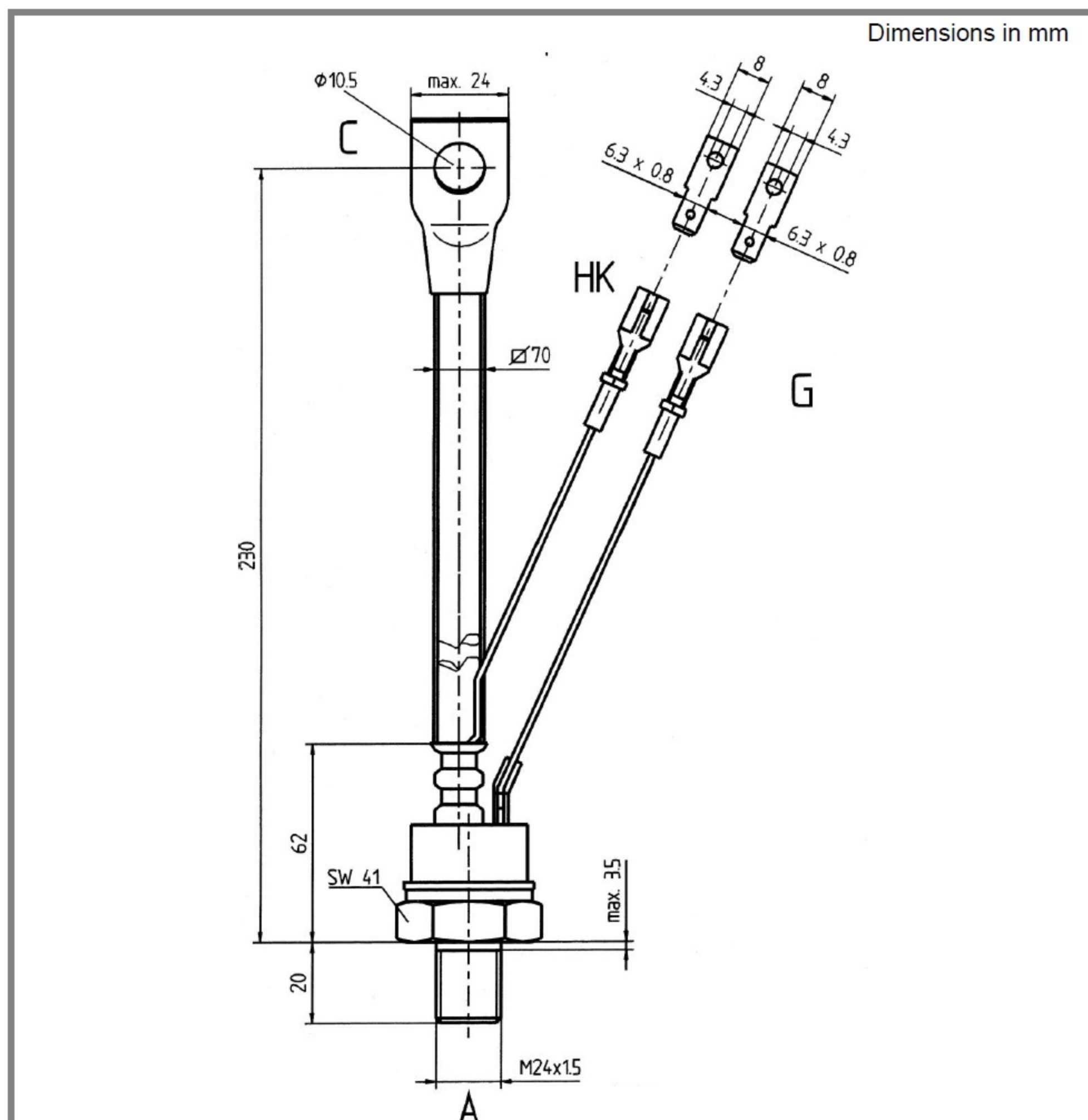

Fig. 9 Gate trigger characteristics



Case B 7 (IEC 60191-2: A29MA; JEDEC: TO-209AD (TO-118))

This technical information specifies semiconductor devices but promises no characteristics. No warranty or guarantee expressed or implied is made regarding delivery, performance or suitability.